

User Manual

17-25KW PV Grid-Tied Inverter



Foreword

The Manual describes the inverter in terms of product details, installation, operation, and maintenance, except for all information of photovoltaic system (PV system). Welcome to visit www.slenergy.com for more details.

Scope

The Manual applies to the following models:

SL17KRG-W, SL20KRG-W, SL22KRG-W, SL25KRG-W

Intended audience

The Manual is available for technical personnel who install, operate, and maintain the inverters and users who check the inverter parameters on the Manual.

The installation and service require knowledge of high voltage electricity and should only be performed by qualified individuals. Slenergy assumes no liability for injury or property damage due to repairs attempted by unqualified individuals or a failure to properly follow this Guide.

The qualified individuals shall satisfy the following requirements:

- They shall be familiar with electronic, electrical wiring and mechanical expertise, and understand electrical and mechanical schematics;
- They shall have received the professional training on installation and commissioning of electrical equipment;
- They shall be able to rttackle with hazards or emergencies during installation or commissioning;
- They shall be acquainted with local standards and relevant safety codes for electrical systems;
- They must read the whole Manual carefully and master the related safety precautions.

Although we are constantly updating and amending the Manual, Product in kind prevail, specifications maybe change without notice.

Contents

Safety Precaution

Warning symbol | Unpacking for inspection | Installation security | Electrical connection security |
Operation security | Maintenance security | Disposing security 3

Product Overview

Dimension and weight | LED indicator | Photovoltaic system | Principle description |
Function description 7

Unpacking and Storing

Unpacking for inspection | Inverter storage 11

Mechanical Installation

Installation precaution | Tool preparation for installation | Installation site |
Space requirement | Installation step 12

Electrical Connection

Safety precaution | Cable requirement | Earthing connection | AC/DC side connection 16

Communicating Connection / Commissioning

Communicating connection | Inspection before commissioning | Commissioning steps 25

Shutdown / Removing / Disposing

Shutting down the inverter | Removing the inverter | Disposing the inverter 26

Troubleshooting & Maintenance

Failure exception | Alarm exception | Regular maintenance | Maintenance notes | Fan maintenance |
Fan cleaning and replacement 27

Quality Warranty

33

Technical Parameters

34

Symbols

This manual contains important safety instructions, which are highlighted with the following symbols, to ensure personal and property safety during usage, or to help optimize the product performance in an efficient way.

Please carefully understand the meaning of these warning symbols to better use the manual.

DANGER

Indicates high-risk potential hazards that, if not avoided, may lead to death or serious injury.

WARNING

Indicates moderate-risk potential hazards that, if not avoided, may lead to death or serious injury.

CAUTION

Indicates low-risk potential hazards that, if not avoided, may lead to minor or moderate injury.

NOTICE

Indicates potential risks that, if not avoided, may lead to device malfunctions or financial losses.









Safety code shall be followed during the installation, commissioning, operation, and maintenance of inverter. A failure to properly follow this Manual.

- **Threatening the personal safety of the operator or third party;**
- **Damaging the inverter or other property of the operator or third party.**

- The manual includes not all safety precautions to be followed, but only serves as a supplement. Therefore, the user shall operate according to the actual situation.
- When installing, operating, and maintaining the equipment, users shall comply with local laws and regulations and codes, supplemented by safety precautions in the Manual.

***To avoid the above hazards, please follow the Manual strictly.**

Warning Symbol

Symbol	Description
	Switch off the machine before any operation and maintenance.
	Beware of scalding due to the equipment surface temperature maybe higher than 60°C.
	Before wiring and checking, ensure that the DC/AC circuit breakers of inverter have been disconnected and wait at least 5 minutes.
	Read the Manual before any operations on the inverter.
	Do not connect and disconnect wires, dismantle the case, and replace devices under electric condition due to the fatal high-voltage risk.
	TÜV mark of conformity.
	Comply with the CE certification.
	Do not discard the inverter as the household waste.
	Reliably earth the inverter for protective grounding.

Unpacking for Inspection

WARNING

- Inspect all safety signs, warning labels, and nameplates on the inverter;
- Ensure that safety signs, warning labels, and nameplates are clearly visible, and not removed or covered before the inverter is discarded.

Installation Security

⚠ DANGER

- Ensure the product has no electrical connections prior to installation;
- Ensure that the drilling, if required during installation, has avoided the electrical wiring inside the wall.

⚠ CAUTION

Improper installation may cause personnel injury!

- Do not stay under the inverter when it is carried and lifted by lifting tools;
- Control the weight when the inverter is carried to keep balance, thus avoiding products toppling or falling.

Electrical Connection Security

⚠ WARNING

- Before electrical connections, ensure that the inverter is intact.
- Before electrical connections, be sure to keep the inverter and all connected switches in "OFF" state to avoid electric shock.

⚠ DANGER

The exposure of PV string to sunlight may cause danger!

- For electrical connections, wear personal protective equipment;
- Ensure that the cable is not charged through checking with test equipment before touching the DC cable;
- Read the safety precautions listed in the PV string-related documents;
- Do not connect the inverter with the PV string that needs either positive or negative grounding.

⚠ DANGER

There may be fatal high voltage inside the inverter!

- Please use special insulation tools when wiring;
- Operate in compliance with the instructions of warning symbols;
- Read safety precautions listed in the Manual and other inverter-related documents.

⚠ WARNING

- Verify the PV string's positive and negative polarities so that the DC connector is connected to the inverter and inserted to the corresponding DC terminal;
- When the inverter is installed and operated, ensure that the positive and the negative of the PV string do not short circuit to the ground. Otherwise, it may lead to inverter AC/DC short circuit, resulting in product damage, which is not covered under warranty.

⚠ WARNING

- Note that the incorrect wiring may damage the product, which is not covered under warranty;
- Electrical connection must be done by qualified individuals;
- Ensure that cables used in the PV system are properly sized, reliably connected, and well insulated.

Operation Security

⚠ DANGER

- Do not touch the product enclosure when it is in operation;
- Do not insert or remove connectors on the inverter when it is in operation;
- Do not touch any terminals on the inverter when it is in operation to avoid electric shock;
- Do not remove any parts of the inverter when it is in operation to avoid electric shock;
- Do not touch the scorching parts of the inverter (e.g. heat sink) when it is in operation to avoid burns;
- Do not shift the DC switch on the product when it is in operation to avoid equipment damage or personnel injury.

Maintenance Security

⚠ DANGER

- Do not touch the Grid or contacts and terminals that are connected to or inside the product to avoid electric shock;
- Use a standard voltmeter to confirm that the Grid is free of voltage before touching to avoid electrical shock.

⚠ DANGER

The improper maintenance may cause personnel injury or product damage!

- Before maintenance, disconnect the Grid-side AC circuit breaker and check the inverter status. switch off the DC switch at night as the inverter indicator is off, and if it is still on, switch off the DC switch directly;
- Use test equipment to check that the inverter is free of voltage and current after 5 min's power off, and then maintain the inverter with protective equipment;
- Avoid burns even after the inverter is shut down. Operate with protective gloves after the inverter has cooled down.

⚠ CAUTION

To avoid unrelated personnel from mishandling or accidents, place obvious warning signs or alarm belts around the products.

Disposing Security

⚠ WARNING

Discard products based on the relevant local regulations and standards to avoid property losses or casualties.

Appearance

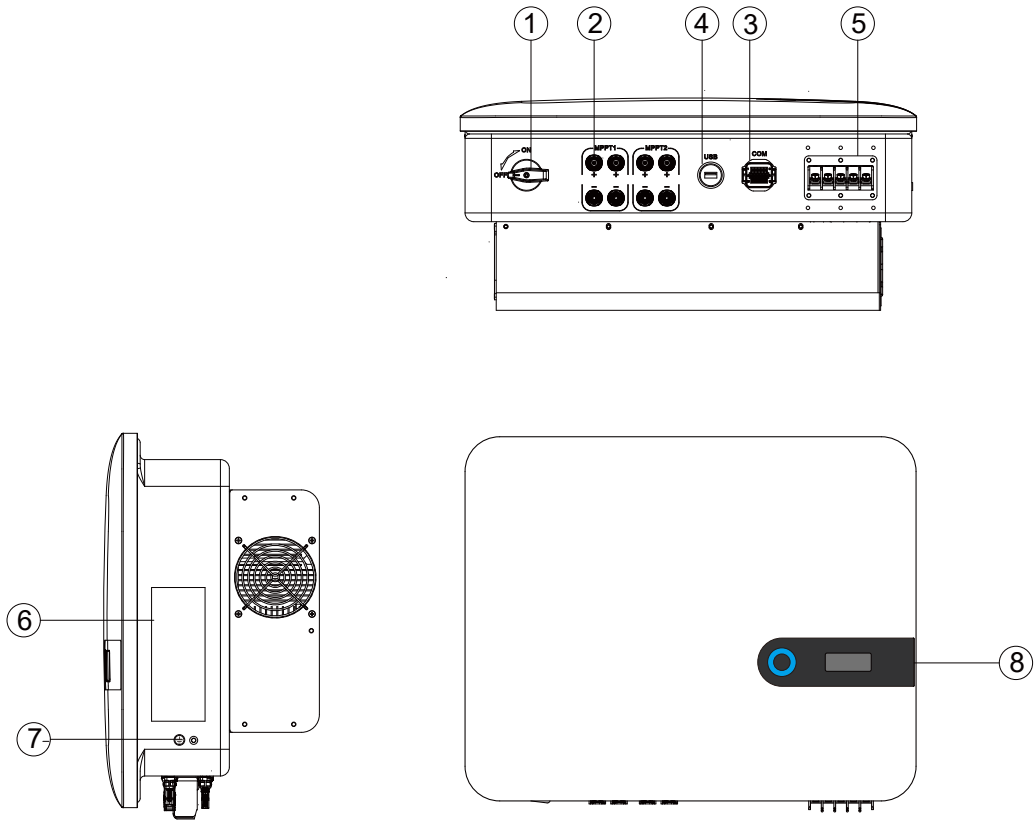

No.	Name	Description
1	DC Switch	For controlling the DC input
2	DC Input Terminals	4 pairs
3	Communication Terminal	Communication interface of RS485 and DRM
4	USB Interface	Wi-Fi/4G monitoring
5	AC Wiring Port	For AC output wiring
6	Labels	Including nameplate, warning label, and QR code
7	External Grounding Terminal	For reliable grounding of inverters
8	LED Indicator & LCD Screen	For indicating the current inverter status

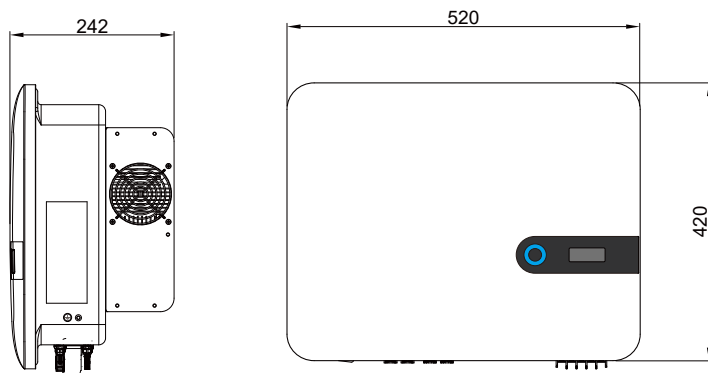

Dimension & Weight



No.	Models	Dimension (W×H×D)	Weight
1	SL17KRG-W SL20KRG-W SL22KRG-W SL25KRG-W	520 x 420 x 242mm	27.2kg

LED Indicator

LED indicator + LCD screen, a human-machine interface on the front panel of inverter, may display the current inverter status.

Indicator	Status	Meaning
	Steady Blue	The inverter is in Grid-connected mode.
	Blinking Blue at 0.2s intervals	USB is connected with data communication and the inverter is free of faults.
	Blinking Blue at 2s intervals	DC or AC is on, and the inverter is in standby or start-up mode (non-Grid-connected mode).
	Steady green	PID enabled
	Blinking Green at 0.2s intervals	Program download
	Steady Red	The inverter is faulty.
	Blinking Red	USB is connected with data communication and the inverter is faulty.
	Off	AC and DC or DC only are/is off.

Note: Since the AC side may still be energized when the indicator is off, it is necessary to avoid electric shock when operating the inverter.

Photovoltaic System

The grid-connected inverter of three-phase transformerless string type is a vital part of PV system.

The inverter converts the DC power from the PV string into AC power that meets the Grid requirements and feeds into the Grid. Typical application scenarios of the inverter are shown below.

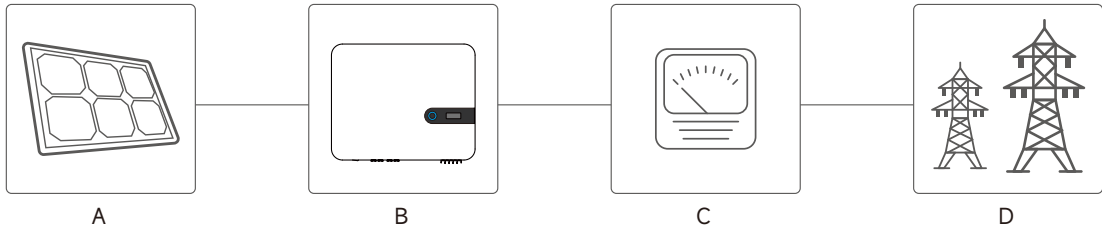

Application of PV Grid-connected inverter to PV system

No.	Name	Description
A	Pv String	Monocrystalline silicon, polycrystalline silicon, and thin-film cell without grounding
B	Inverter	SL17KRG-W, SL20KRG-W, SL22KRG-W, SL25KRG-W
C	Electricity Meter	A standard tool for metering inverter output power
D	Grid	Types of Grid supported by the inverter are shown below

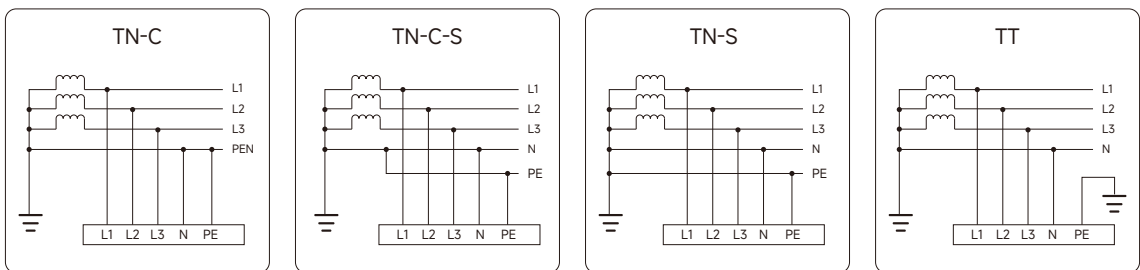

Types of Grid supported by the PV Grid-connected inverter

⚠ WARNING

- Do not connect the inverter with the PV string that needs either positive or negative grounding.
- When installing or operating the inverter, ensure the positive and negative of the PV string are short-circuit to the ground. Otherwise, it may lead to inverter AC/DC short circuit, resulting in product damage, which is not covered under warranty.
- Do not connect local loads between the inverter and AC-side circuit breaker.
- Use the inverter only in the scenarios described in the Manual.

Principle Description

The principle design of inverter is illustrated below:

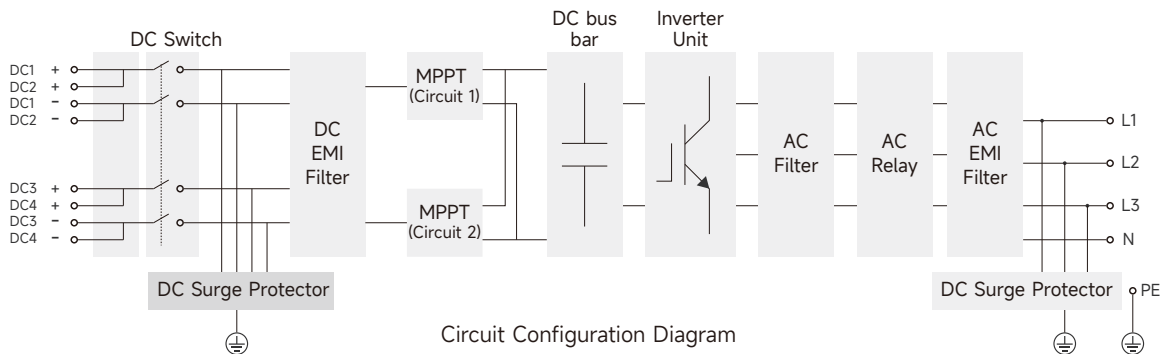

- If needed, use the DC switch to safely cut off the DC current to keep the operating inverter and personnel safe;
- EMI filter removes the electromagnetic interference inside the inverter to ensure that the inverter meets the EMC standards;
- The inverter provides DC input via two MPPT circuits, ensuring maximum power even under different PV input conditions;
- The inverter converts the DC power into AC power that meets the Grid requirements and feeds into the Grid;
- The AC filter removes the high-frequency component of output current from the inverter, ensuring that the output current meets the Grid requirements;
- The output relay isolates the AC output of inverter from the Grid so that the inverter can be safely disconnected from the Grid in case of inverter or Grid failure;
- The AC surge protector provides a relief circuit to the AC-side overvoltage energy to prevent its energy shock from damaging the inverter's internal circuit.

Function Description

The inverter has the following functions in summary:

Inverse transformation	Convert DC power into AC power that meets the requirements of the Grid and feeds it into the Grid.
Data storage	Save system information, such as operation information and fault records.
Parameter configuration	Provide users with multiple parameter configurations, so that they may adjust the inverter by using App to meet various needs, such as the best operating performance.
Communication interface	Provide communication accessory port to access the Company's communication module. Upload monitoring data through wireless communication to the monitoring backend that has connected with the communication device, allowing users check the inverter information or set operation and protection parameters through the Smart Energy Management Platform, etc.
Protection	Provide anti-island protection, DC reverse-connection protection, AC short-circuit protection, leakage-current protection, surge protection, etc.

Unpacking for Inspection

Although the equipment is completely tested and inspected before shipping, damages may still occur during transportation. So, users shall inspect the product in detail before signing.

- Check packing boxes for damages;
- Check if the goods are complete and consistent as per the packing list;
- Unpack and check if the internal parts are intact;
- In case of any damage or incomplete goods, contact the transport company or Slenergy and provide photos of the damage for accurate service;
- Do not discard the shipping packaging of equipment after it is removed, but store it in the original packing box.

The packing list is as follows:

Inverter	1	16Pin Communication Connection	1
Wall Mount	1	Accessory Kit of Installing Screw	1
DC Connectors	4	Connector Protective Sleeve	1
Circular Connector	6	Quick Installation Guide	1
OT Terminals	1	Passport	1

Inverter Storage

The inverter shall be stored in a specific condition if it is not operated at once:

- It shall be repacked by the shipping packing box with the desiccant;
- It shall be stored at a temperature range from -30°C ~ 70°C , with a relative humidity range from 0% ~ 95% and without condensation;
- The stacking of multiple inverters shall adhere to the "maximum stacking layers limit" indicated on the outer box;
- The packaging box may not be tilted or reversed;
- The inverter shall be carefully packaged before re-transportation;
- It shall not be stored in places exposed to direct sunlight, moisture from rain, strong electric fields, etc.;
- It shall not be stored together with objects that may damage the inverter;
- It shall be stored in a clean and dry place to protect it from the erosion of dust and water vapor;
- It shall not be stored in places with chemical corrosive substances or susceptible to pest infestation;
- Regular inspections shall be conducted at least half a year. In case of any signs of peat or rodent damage, the packaging materials need to be replaced;
- If the inverter has been in warehouse for one year or longer, it requires professional inspection and testing before operation.

This chapter describes the inverter installation and its connection to the PV system; For connection of the PV inverter to the PV system, it includes inverter's connection to the PV string and public grid;

Prior to inverter installation, users shall read this chapter and ensure it is installed by professional personnel after meeting all installation conditions.

Installation Precautions

⚠ DANGER

- Ensure that the product has no electrical connections before installation;
- Ensure that the drilling, if required during installation, has avoided the electrical wiring inside the wall.

⚠ WARNING







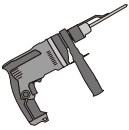

- Avoid improper installation conditions affecting the inverter's performance;
- Install the inverter in a well-ventilated place;
- Ensure that product cooling system or ventilation port is uncovered;
- Do not install the inverter in a flammable, explosive, or smoky environment.

⚠ CAUTION

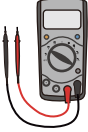
- Improper installation may cause personnel injury!
- Control the weight when the inverter is carried to keep balance, thus avoiding the inverter toppling or falling;
- Wear suitable protective equipment when operating the inverter;
- Do not expose the inverter and its bottom terminals and interfaces directly to the ground or other supports.

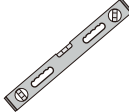
Tool Preparation for Installation

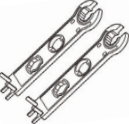
Before installation, the prepared tools include but are not limited to the recommended tools below, with other auxiliary tools available if needed.

			
Marker	Electric drill	Hammer	Wrench
			
Electric meter	Hydraulic clamp	MC4 crimping pliers	Spirit level
			
Socket wrench	MC4 wrench	Utility knife	Cross screwdriver

Installation Site

- For the inverter, optional installation sites play a vital role in ensuring its safe operation, long service life, and good performance;
- With IP66 protection class, the inverter may be installed indoors or outdoors, but for longer service life, it is more suitable for installation in a sheltered place, such as with an awning;
- The installation site shall be easily accessible for electrical connections, operation, and maintenance;
- Due to relatively high temperature at case and heat sink during operation, the inverter shall be placed in a site that is not easily accessible;
- The inverter shall not be installed in a flammable and explosive site;
- The inverter shall be installed in an airy place for good heat dissipation;
- The temperature for installation shall be $-25^{\circ}\text{C} \sim 60^{\circ}\text{C}$;
- The installation site shall be away from electronic equipment with strong electromagnetic interference;
- The installation site shall be a fixed and solid surface, such as wall, metal bracket, etc.;
- In a suitable installation location, the inverter shall be reliably grounded and the grounding metal conductor material shall be consistent with that of the inverter reserved grounding.

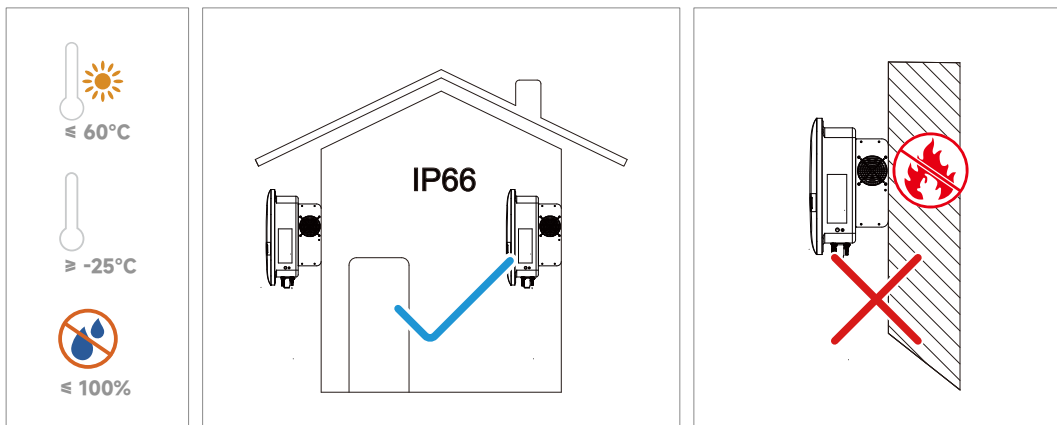

Space Requirements

At a suitable installation height, the user's sight is at the same level as the display window of LED and LCD, making it easy to check the inverter status.

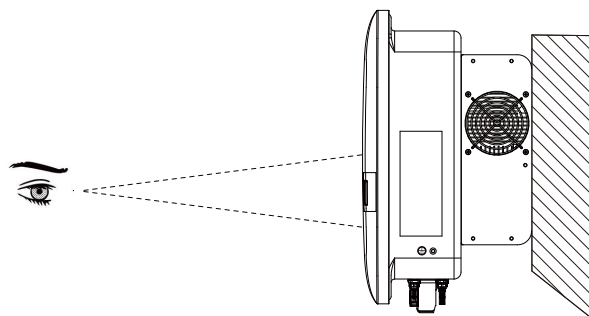

Sufficient reserved space around the installation site may facilitate the inverter disassembly and air convection. The installation space requirements for a inverter are illustrated on the right.

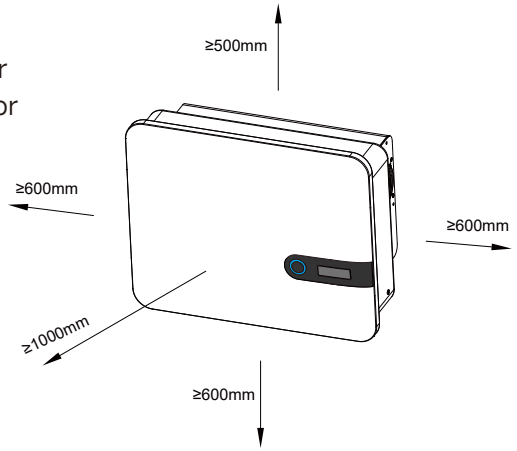

When multiple inverters are installed, a certain distance shall be reserved between inverters, and a linear installation is recommended. The left and right spacing is shown below.

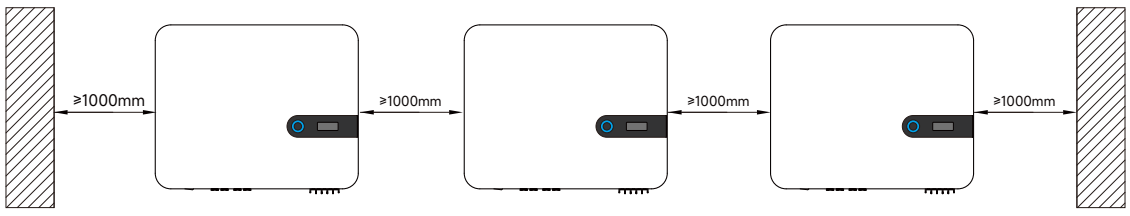

Linear installation

The inverter is recommended to be installed vertically for heat dissipation, avoiding forward-leaning, backward-leaning, reverse, horizontal, or inclined installations.

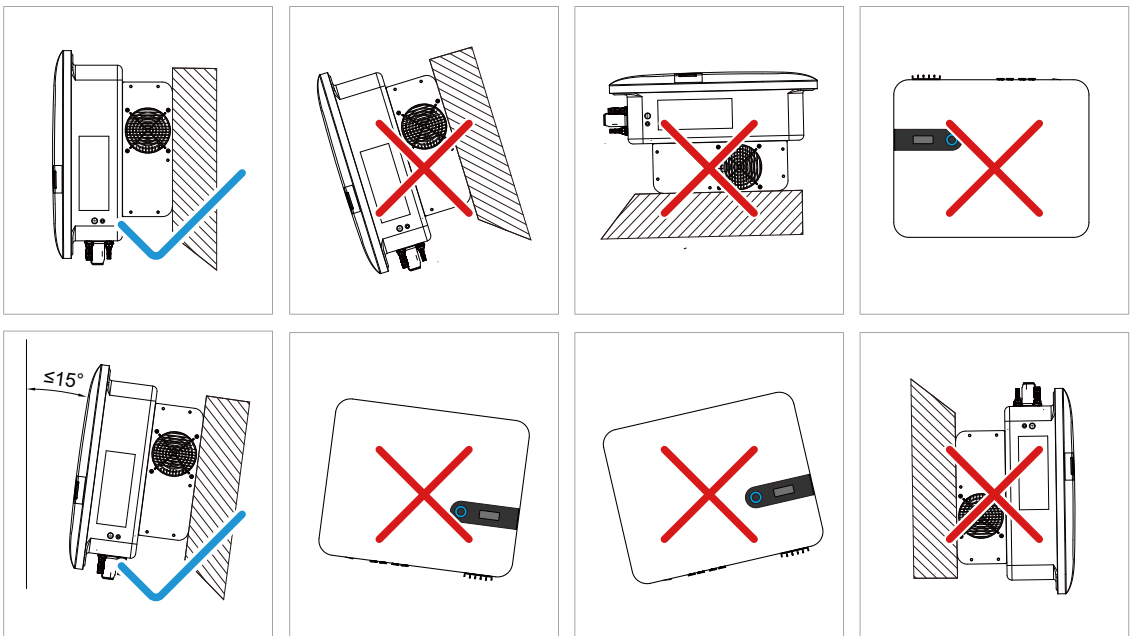

Installation Steps

Before drilling, avoid the electrical wiring inside the wall!

STEP 1:

Draw a horizontal reference line with a level on the wall.

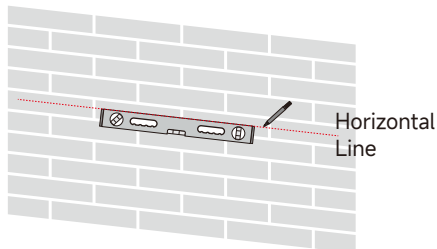

STEP 2:

Place the hanging plate flush on the wall, mark the recommended holes as shown, and drill the holes to a depth of about 70 mm.

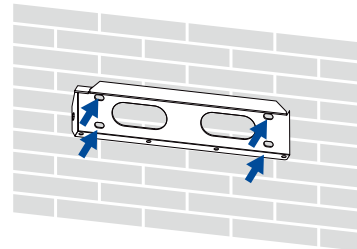

STEP 3:

Knock the plastic expansion pipe into the hole.

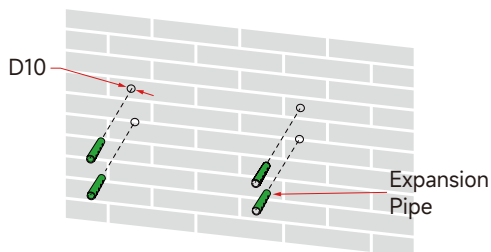

STEP 4:

Use the self-tapping screw+flat washer to fix the hanging plate on the wall with a tightening torque of 9 N.m.

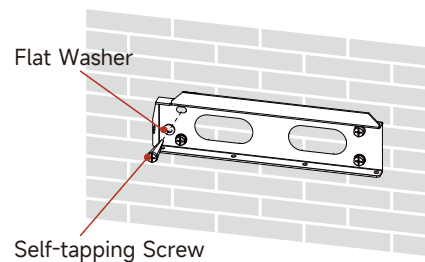

STEP 5:

Lift the inverter and hang the installation lug to the hanging plate. Release your hands until the inverter has been fixed in the backing plate.

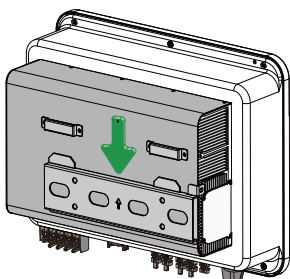

STEP 6:

In terms of the left side hole of case and wall hangings, fasten the inverter to the hanging plate using M4x12 screws, with a torque of 1.5 N.m.

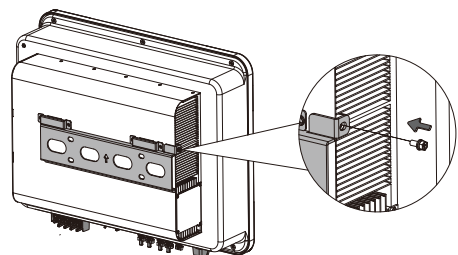

Safety Precaution

Remember that the inverter has dual power before electrical connection. Wear protective equipment during electrical connection.

Name	Mark	Quantity
DC Input Terminals	MPPT1+MPPT1- MPPT2+MPPT2-	MC4 PV connection SL17KRG-W、SL20KRG-W、SL22KRG-W、SL25KRG-W: 4 pairs of terminals; 4 PV strings
Communication Terminal	COM/USB	Suitable for RS485/DRM/GPRS/WiFi communication module
AC Output Terminal	AC	For Grid connection, use the circular connector in the accessory
Protective Earth Terminal		Use protective earth terminal for reliable secondary grounding

Cable Requirements

Name	Type	Specification/Outer Diameter (mm)	Conductor Cross-sectional Area(mm ²)
DC Cable	Multi-core PV cable with a maximum tolerance voltage of 1,100 V	6~9	2.5 ~ 6, Recommended value 5
AC Cable	Outdoor Copper-core Cable	10~26	8 ~ 15, Recommended value 12
Secondary Grounding Cable	Outdoor single-core copper wire	/	≥10mm ²

External Grounding Connection

For the transformerless inverter, it is vital to note that the positive and negative terminals of the PV string shall not be grounded, otherwise, the inverter cannot operate normally. The external grounding connection shall be conducted before the AC-side connection, PV string connection, and communication connection.

The grounding connection of the external PE terminal shall not replace that of the AC wiring. Both connections shall be reliably grounded. Otherwise, the Slenergy assumes no liability for any potential consequences.

External Grounding Requirements

- The external grounding cable should be yellow green wire.
- In PV systems, all non-current-carrying metal parts and equipment enclosures shall be grounded (e.g. PV brackets, inverter enclosures, etc.)
- For a inverter, the external grounding terminal is required to be grounded at the near end.
- For multiple inverters, all external grounding terminals and the grounding points of PV brackets shall be connected to an equipotential line (as per case-specific analysis) to ensure equipotential connection.

Grounding Steps

The cross-section area of the secondary grounding cable must be identical to that of the PE core wire in the AC cable.

STEP 1: Assemble the cable and crimp the OT/DT terminals.

STEP 2: Remove the screws from the grounding terminal and fix the cable using a screwdriver.

STEP 3: Apply silicone gel or paint to the grounding terminal to enhance its corrosion resistance.

END

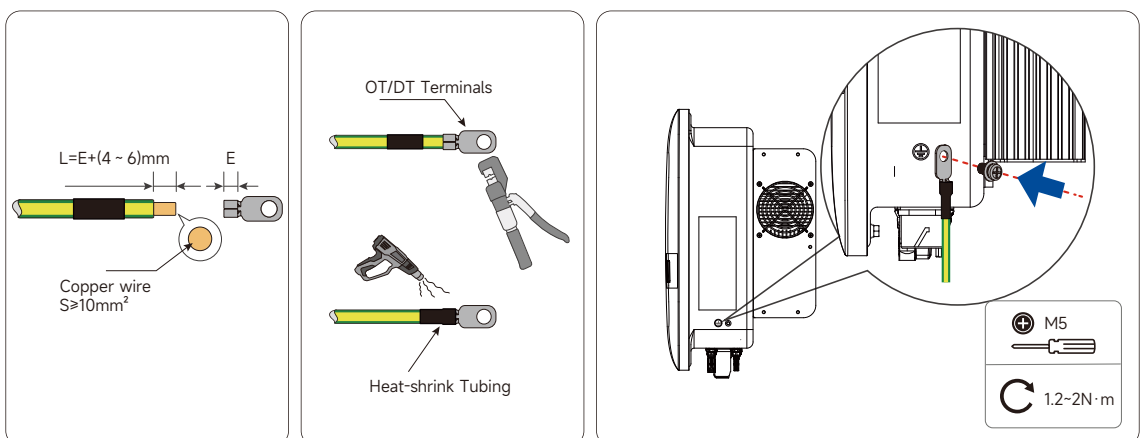

AC-side Connection Requirement

Before connecting the AC side to Grid, the Grid voltage and frequency shall comply with the requirements of the inverter. See Technical Data for detailed parameters. If not, users shall contact the power utility company for resolution.

***Inverters may be connected to the Grid only with the access permit of the local power utility company.**

AC Circuit Breaker

Equip each inverter with an independent three-pole or four-pole circuit breaker on the AC side to make a safe disconnection between the inverter and Grid.

Inverter Model	Recommended AC Circuit Breaker Parameters
SL17KRG-W	32A
SL20KRG-W, SL22KRG-W, SL25KRG-W	63A

- Multiple inverters shall not share a single AC circuit breaker.
- No load shall be connected between the inverter and AC circuit breaker.

Leakage-current Protector

An integrated leakage-current monitoring unit is equipped inside the inverter, which will quickly disconnect the inverter from the Grid when a leakage current is detected greater than the allowed value.

Com Communication Interfaces

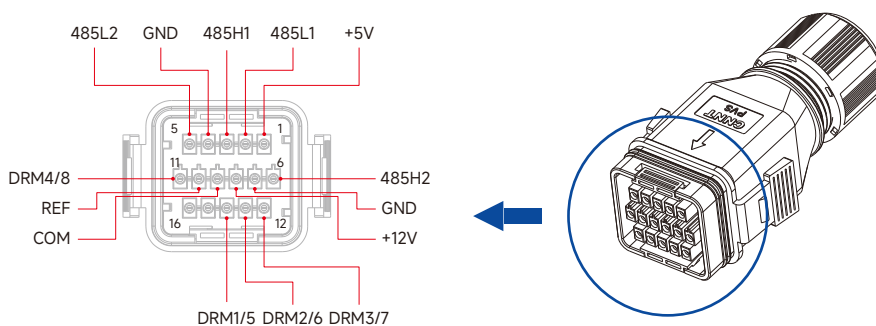

AC-side Wiring

- STEP 1:** Disconnect the AC-side circuit breaker and prevent it from reconnecting by accident.
- STEP 2:** Remove the AC circular connector and loosen the lock nut of waterproof connector. Select the sealing washer according to the cable outer diameter. Thread the cable through the lock nut in sequence.
- STEP 3:** Strip off a certain length of the protective layer and insulation layer as per the diagram requirements.
- STEP 4:** Assemble the cable and lock the circular connector in place.
- STEP 5:** Fix the cable to the corresponding terminal. Ensure that the cable is securely connected by pulling it outward.
- STEP 6:** Slightly pull the cable backward and clockwise tighten the lock nut.
- End

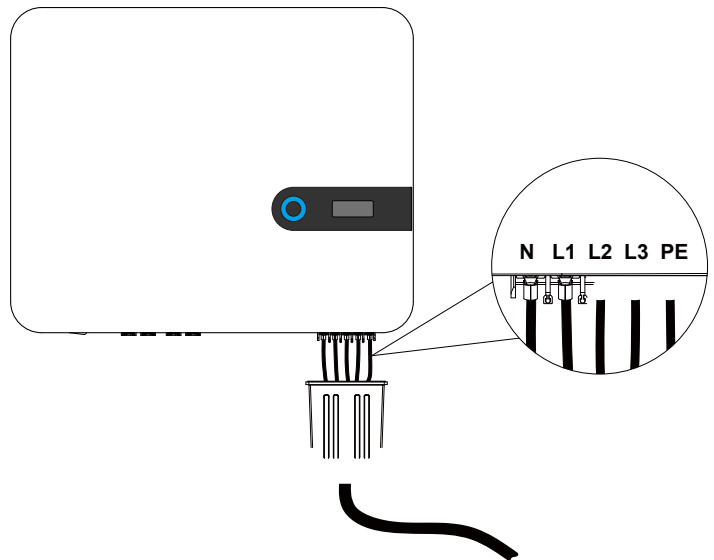
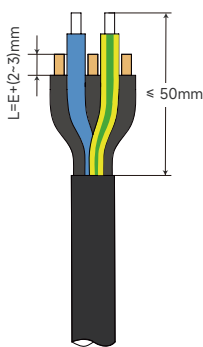

⚠ CAUTION

- After the circular connector is wired and installed on the machine, the connector protective sleeve must be locked. Unqualified individuals are not allowed to operate.
- Pay much attention to the positioning of the "PE" cable and "N" cable. If the phase wire is connected to the terminal of "PE" or "N" cable, the inverter may be permanently damaged.

DC-side Connection

⚠ ELECTRIC SHOCK

- Before electrical connection, protect the PV array from exposure to sunlight, otherwise it may cause risky voltages;
- Ensure good insulation of the PV array from the ground before connecting it to the inverter;
- When the inverter is installed and operated, ensure that the PV string is not short-circuit for positive or negative polarity to ground. Otherwise, it may lead to inverter AC/DC short circuit, resulting in product damage, which is not covered under the warranty.

- The connection of the PV string shall meet the following requirements, otherwise the inverter may be permanently damaged, and such damage is not covered under the warranty;
- The voltage and maximum short-circuit current of each PV string shall be within the range. See Technical Data for details;
- When the same PV string is mixed with different brands or models of PV modules or connected to PV modules with different orientation angles or tilt angles, such conditions may not damage the inverter, but will affect the system performance.
- When the input voltage is 1,000V ~ 1,100V, the inverter will be in the standby mode. When the voltage is restored within the MPPT working voltage range of 160V ~ 1,000V, the inverter will return to its normal operation.

PV Input Configuration

Each of the SL17KRG-W, SL20KRG-W, SL22KRG-W, and SL25KRG-W inverters is provided with dual PV input sections, each of which is equipped with a separate MPPT for independent operation. To maximize the utilization of PV cell panel input power, the PV strings in the same input section shall be consistent in terms of the following aspects: identical model, number of cell panels, tilt angle, and azimuth angle. PV strings in different input sections may have different configurations, including disparate types of cell panels, number of panels in the string, tilt angle, and azimuth angle.

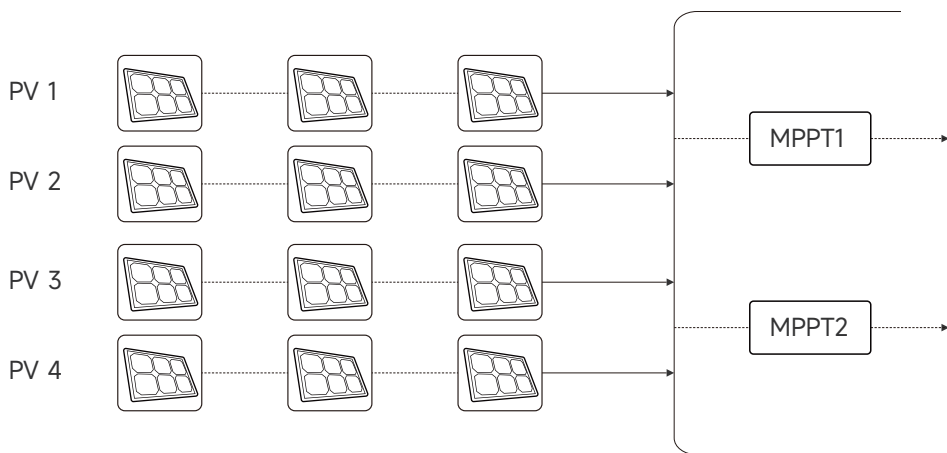

The configuration shall satisfy the following requirements before connecting the PV input to inverter.

Models	Open-circuit voltage per input	Maximum input current per string
All Models	1100V	32A

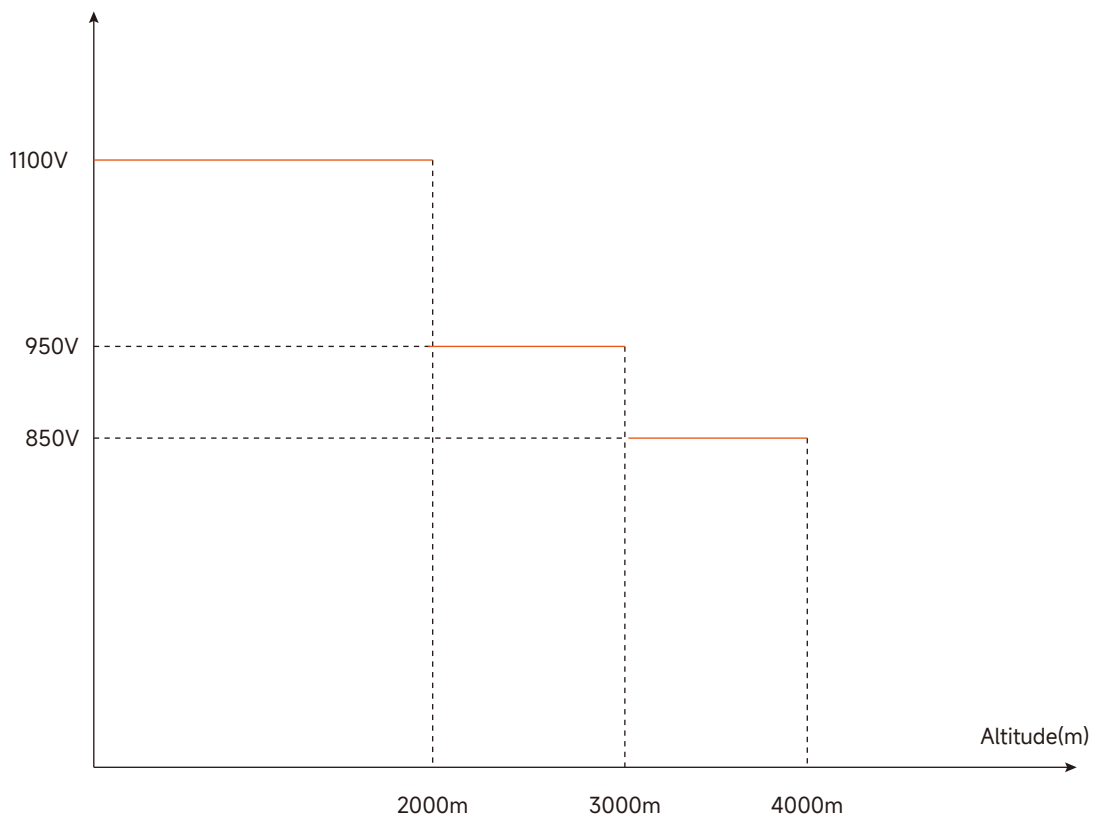

Assembling DC Connectors

⚠ CAUTION

- Beware of high voltage in the inverter!
- Ensure all cables are uncharged before electrical connection;
- Keep the AC circuit breaker switch off before connecting the electrical to the inverter;
- Use the MC4 DC terminal in the shipping accessories when the maximum DC input voltage is not more than 1,000V;
- If the maximum DC input voltage exceeds 1,000V, use MC4-Evo2 DC terminal. Please contact the Company if needed;
- Please choose the required terminals, if not, the damage is not covered under the warranty.

***Use only the supplied connectors to ensure that the inverter has an IP66 protection class.**

STEP 1:

Strip 7 mm of insulation layer from each DC cable.

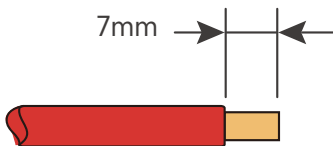

STEP 2:

Harness cable wire ends at wire terminals with crimping pliers.

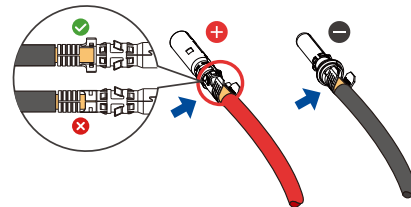

STEP 3:

Thread the cable into the cable gland and fasten it by inserting it into the insulating sleeve. Pull the cable lightly to ensure it is connected tightly. Fasten the cable gland and the insulating sleeve with a force of 2.5 N·m ~ 3 N·m.

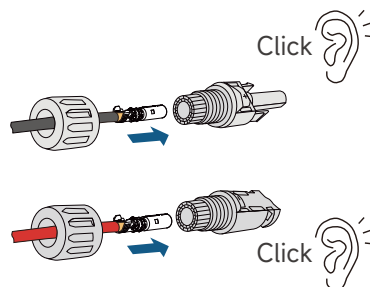

Ensure that the PV string is connected to the correct cable polarity.

If the DC input polarity is reversed, the inverter in fault or alarm status fails to operate normally.

Installing DC Connectors

STEP 1:

Rotate the DC switch to "OFF".

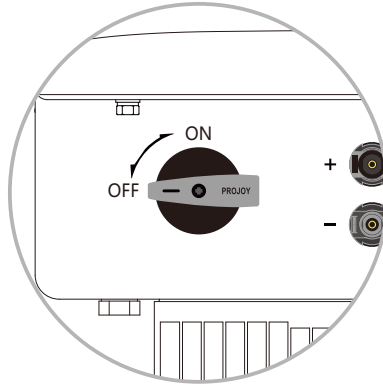

STEP 2:

Check whether the PV string is connected to the correct cable polarity, and ensure that the open-circuit voltage never exceeds the upper inverter input limit of 1,100V.

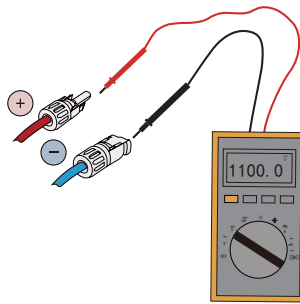

STEP 3:

Connect other PV strings as above and block the vacant DC terminals with MC4 waterproof plugs.

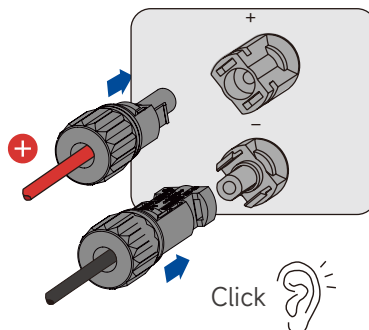

Communicating Connection

The wireless communication module is installed to the communication accessory port (silkscreen marked USB) at the bottom of inverter.

Via the communication accessory port, users can access the Wi-Fi wireless communication module from our company. You can check the power generation and operation status of inverter through the mobile App after successful connection.

Please see the Manual for its installation, configuration and the supporting App.

DANGER

- Beware of high voltage in the inverter;
- Avoid the exposure of PV string to sunlight, otherwise, it may cause hazardous voltage;
- Keep the AC/DC circuit breaker switch off before connecting to avoid a false connection;
- Ensure all cables are uncharged before electrical connection.

WARNING

- During wiring, avoid any improper operation that may cause product damage or personnel injury;
- Complete wiring operations only by professional personnel;
- Use solid, intact, well-insulated and properly sized cables for PV systems.

CAUTION

- Follow local Grid-related rules and PV string-related safety instructions during wiring;
- Ensure that all electrical installations meet the relevant standards of the country/region in which it is located;
- Connect the inverter to Grid only with the permission of local power department.

Inspection Before Commissioning

The inverter needs to be inspected before its first start-up as follows:

S/N	Inspection Item	Inspection Result	
		Normal	Abnormal
1	Check and confirm that all equipment is reliably installed.	<input type="checkbox"/>	<input type="checkbox"/>
2	Check if the DC switch and AC breaker are in "OFF".	<input type="checkbox"/>	<input type="checkbox"/>
3	Check the ground wire for proper connection.	<input type="checkbox"/>	<input type="checkbox"/>
4	Check the AC cable for proper connection.	<input type="checkbox"/>	<input type="checkbox"/>
5	Check the DC cable for proper connection.	<input type="checkbox"/>	<input type="checkbox"/>
6	Check the communication cable for proper connection.	<input type="checkbox"/>	<input type="checkbox"/>
7	Check if vacant terminals are sealed.	<input type="checkbox"/>	<input type="checkbox"/>
8	Ensure that no construction tools are left on top of the equipment or inside the wiring box (if any).	<input type="checkbox"/>	<input type="checkbox"/>
9	Select AC circuit breakers as per the Manual and local standards.	<input type="checkbox"/>	<input type="checkbox"/>
10	Ensure that all safety signs and warning labels are fixed and visible.	<input type="checkbox"/>	<input type="checkbox"/>
11	Check if the connector protective sleeve is locked after the installation of the AC circular plug.	<input type="checkbox"/>	<input type="checkbox"/>

Commissioning Steps

- STEP 1:** Rotate the DC switch on the inverter to "ON".
- STEP 2:** Turn on the AC switch if it is configured between the inverter and Grid.
- STEP 3:** Turn on the AC switch if it is configured between the inverter and PV string.
- STEP 4:** Ensure that there is plenty of light and it meets the requirements for Grid connection to make the inverter operate normally.
- STEP 5:** Observe the status of LED indicator (and see LED Indicator for details).
End

Shutting Down The Inverter

Avoid burns even after the inverter is shut down. Operate with protective gloves after the inverter has cooled. Shut down the inverter for maintenance or repair (except under normal circumstances). Disconnect the inverter from the AC/DC power supply according to the following steps to avoid casualties or equipment damage.

- STEP 1:** Disconnect the external AC circuit breaker and avoid reconnection by improper operation.
- STEP 2:** Disconnect the external DC circuit breaker and rotate the DC switch of inverter to "OFF".
- STEP 3:** Wait at least 10 min to discharge the internal capacitance completely.
- STEP 4:** Use the current clamp to confirm that there is no current on the DC cable.
End

Removing The Inverter

⚠ BURNS AND ELECTRIC SHOCK

- Disconnect the inverter from Grid and PV cell panels, and wait at least 10 min before touching the internal conductive device;
- Before removing the inverter, disconnect both AC and DC connections;
- When the DC terminal of inverter exceeds two layers, remove the outer DC connector first, and then remove the inner DC connector.

With reference to Electrical Connection, disconnect all electrical connections of inverter in reverse steps. Specifically, use the MC4 wrench to remove the DC connector by loosening its locking parts, and install the waterproof plug.

With reference to Mechanical Installation, remove the inverter in reverse steps.

If needed, remove the hanging plate on the wall.

Please see Inverter Storage to store the inverter properly for future use.

Disposing The Inverter

- Handle the inverter by users themselves;
- Avoid environmental pollutions caused by some parts and equipment of inverter, such as capacitors;
- Do not mix the disposed inverter with household waste., Follow the electronic waste regulations.

Failure Exception

Once the inverter is faulty, you can check the corresponding fault information via fault codes on the mobile App or PC interface. All fault codes and troubleshooting methods of the PV inverter are detailed in the following table, only some of which may be applicable for the model you purchased.

Main Code	Type	Sub Code	Fault Information	Troubleshooting Method
1	PV voltage fault	1	Low PV voltage	Check the inverter voltage and current abnormalities to determine fault causes: <ul style="list-style-type: none"> • Check if parts corresponding to the fault is obscured, and if so, remove the shelters and ensure that the parts are clean; • Check the cell panel wiring for loose connections, and if so, replug it to ensure its stable connection; • Check the DC fuse for damage, and if so, replace it; • Contact the Customer Service Center if the fault still exists not for the above reasons;
		2	High PV voltage	
2	PV reverse-connection fault	1	PV1	<ul style="list-style-type: none"> • Check if the positive and negative polarity of corresponding strings on the inverter is reversed, and if so, wait until the photovoltaic modules string current is lower than 0.5 A, turn off the DC switch, and adjust the opposite string polarity; • Contact the Customer Service Center if the fault still exists not for the above reasons;
		2	PV2	
		3	PV3	
		4	PV4	
3	PV short-circuit fault	1	PV1	<ul style="list-style-type: none"> • Contact the Customer Service Center if the fault still exists not for the above reasons;
		2	PV2	
		3	PV3	
		4	PV4	
4	BUS voltage fault	1	Low BUS voltage	<ul style="list-style-type: none"> • Check if parts corresponding to the fault is obscured, and if so, remove the shelters and ensure that the parts are clean; • Check the cell panel wiring for loose connections, and if so, replug it to ensure its stable connection; • Check the DC fuse for damage, and if so, replace it; • Contact the Customer Service Center if the fault still exists not for the above reasons;
		2	High BUS voltage	
		3	Unbalanced BUS voltage	<ul style="list-style-type: none"> • Check the cell panel wiring for loose connections, and if so, replug it to ensure its reliable connection; • Check the DC fuse for damage, and if so, replace it; • Via the monitoring software, confirm the voltage of positive BUS and negative BUS, and calculate their voltage difference. When the above value exceeds the equipment protection threshold (50 V), contact the Customer Service Center;
5	Over-current fault	1	Inverter hardware overcurrent	<ul style="list-style-type: none"> • Check if parts corresponding to the fault is obscured, and if so, remove the shelters, ensure that the parts are clean, and then connect it to grid; • In case of AC overcurrent, check if the grid voltage fluctuation exceeds 50 V, and if so, wait for the local grid to stabilize and then connect to the grid; • Contact the Customer Service Center if the fault still exists not for the above reasons;
		2	Inverter software overcurrent	
		3	BOOST hardware overcurrent	
		4	BOOST software overcurrent	
		5	PowerFail	
		6	Bus hardware overvoltage	
6	Temperature fault	1	Abnormal inverter temperature	Generally, the inverter will operate again after its internal or module temperature returns to normal, but if the fault recurs: <ul style="list-style-type: none"> • Check the inverter for high ambient temperatures; • Check if the inverter is located in an airy place; • Check if the inverter is exposed to direct light, and if so, provide some shelters;
		2	Abnormal BOOST temperature	

Failure Exception

Main Code	Type	Sub Code	Fault Information	Troubleshooting Method
6	Temperature fault	3	Abnormal ambient temperature	<ul style="list-style-type: none"> • Check the fan for normal proper operation, and if not, replace it; • Contact the Customer Service Center if the fault still exists not for the above reasons. Shut down and disconnect the inverter, wait for the ambient temperature rising to the normal operating temperature range, and then restart the inverter;
7	Insulation-detection fault	1	Low insulation impedance	Wait for the inverter to return to normal, but if the fault is repeated: <ul style="list-style-type: none"> • Via the App, check if the ISO impedance-protection value is too high and confirm that it meets local regulatory requirements; • Check the earth impedance of photovoltaic modules strings and DC cables and take corrective measures if there is a short circuit or the insulation layer of the cable is damaged; • If the fault occurs on rainy days (with normal cables), reconfirm it when the weather condition improves; • Contact the Customer Service Center if the fault still exists not for the above reasons;
8	Drive failure	1	Drive failure	Contact the Customer Service Center
9	Communication fault	1	ARM to main DSP communication fault	<ul style="list-style-type: none"> • Check if the communication wire or collection stick is loose, and if so, rewire or replug the collection stick; • Contact the Customer Service Center if the fault still exists not for the above reasons.
		2	Main DSP to ARM communication fault	
		3	ARM to main DSP communication fault	
		4	Main DSP to ARM communication fault	
		5	Main-slave chip communication fault – main chip fault	
		6	Main-slave chip communication fault – slave chip fault	
10	Leakage-current fault	1	High-static leakage current	<ul style="list-style-type: none"> • A humid cell panel condition or poor lighting may cause the fault. Generally, reconnect the inverter to the grid after the condition has improved; • If the environment is normal, check if the DC/AC cable insulation is normal; • Contact the Customer Service Center if the fault still exists not for the above reasons.
		2	30 mA abrupt fault	
		3	60 mA abrupt fault	
		4	150 mA abrupt fault	
11	Relay Fault	1	Short circuit of R-phase relay	Contact the Customer Service Center
		2	Short circuit of S-phase relay	
		3	Short circuit of T-phase relay	
		4	Short circuit of R-phase DSP relay	
		5	Short circuit of S-phase DSP relay	
		6	Short circuit of T-phase DSP relay	
		7	Short circuit of R-phase M0 relay	

Failure Exception

Main Code	Type	Sub Code	Fault Information	Troubleshooting Method
11	Relay fault	8	Short circuit of S-phase M0 relay	Contact the Customer Service Center
		9	Short circuit of T-phase M0 relay	
		10	Relay protection fault	
12	DCI Fault	1	R-phase DCI fault	
		2	S-phase DCI fault	
		3	T-phase DCI fault	
13	Signal Sampling Fault	1	Inconsistent BUS voltage detection	
		2	Inconsistent BOOST current detection	
		3	Inconsistent ISO voltage detection	
		4	Inconsistent PV voltage detection	
		5	Inconsistent GFCI	
		6	Abnormal BUS voltage sampling	
		7	Abnormal PV current sampling	
14	Mains voltage fault	1	No mains voltage fault	In general, reconnect the inverter to the grid after the grid returns to normal. If the fault is repeated: <ul style="list-style-type: none"> • Check if the grid is stably supplied; • Check if the AC wiring is tight; • Check if the AC cable is connected to the correct terminal (or if the fire wire is connected to the N wire); • Check if the AC circuit breaker is turned on; • Contact the Customer Service Center if the fault still exists not for the above reasons.
		2	Mains under-voltage level 1	
		3	Mains under-voltage level 2	
		4	Mains overvoltage level 1	
		5	Mains overvoltage level 2	
		6	Mains start-up under-voltage	
		7	Mains start-up overvoltage	
		8	Interrupt instantaneous under-voltage	
		9	Interrupt instantaneous overvoltage	
15	Mains frequency fault	1	Mains underfrequency level 1	In general, reconnect the inverter to the grid after the grid returns to normal. If the fault is repeated: <ul style="list-style-type: none"> • Measure the actual grid frequency, and if it exceeds the set range indeed, contact the local power utility company for resolution; • Check if the set protection parameter is qualified; • Contact the Customer Service Center if the fault still exists not for the above reasons.
		2	Mains underfrequency level 2	
		3	Mains overfrequency level 1	
		4	Mains overfrequency level 2	
		5	Mains start-up underfrequency	
		6	Mains start-up overfrequency	
16	Remote shutdown	1	Shutdown fault	Contact the Customer Service Center
17	Leakage current self-test fault	1	Leakage current sensor fault	
18	Strings detection fault	1	Strings detection fault	

Failure Exception

Main Code	Type	Sub Code	Fault Information	Troubleshooting Method
19	Auxiliary power fault	1	Auxiliary power failed	Contact the Customer Service Center
20	USB flash drive file format fault	1	Multi-file format fault for USB flash drive upgrade	

Alarm Exception

Main Code	Type	Sub Code	Fault Information	Troubleshooting Method
1	Abnormal fan-speed alarm	1	Fan 1	<ul style="list-style-type: none"> Contact the Customer Service Center.
		7	Internal fan 1	
3	Abnormal string alarm	01	Abnormal string 1 alarm	<ul style="list-style-type: none"> Check whether the number of cell panels configured for the corresponding string is fewer than other strings, and if so, wait until the photovoltaic modules string current is lower than 0.5 A, turn off the DC switch, and adjust the panel configuration for the string; Check the cell panels of string for shelters; Wait until the photovoltaic modules string current is lower than 0.5 A, turn off the DC switch, and check if the open-circuit voltage of string is abnormal. If so, check the cell panel for its wiring and configuration; Check the cell panel for its abnormal orientation;
		02	Abnormal string 2 alarm	
		03	Abnormal string 3 alarm	
		04	Abnormal string 4 alarm	
4	Meter/CT reverse-connection alarm	01	Abnormal alarm of A-phase meter	<ul style="list-style-type: none"> Check the meter for improper position of wiring; Check if the input and output wiring direction of meter is reversed; If the retrofit system is enabled, check if the rated power is correctly set for the inverter;
		02	Abnormal alarm of B-phase meter	
		03	Abnormal alarm of C-phase meter	
		04	Abnormal meter communication alarm	
		05	Abnormal CT wiring alarm	
5	Grid overload alarm	01	Overvoltage alarm	In general, reconnect the inverter to the grid after the grid returns to normal. If the fault is repeated: <ul style="list-style-type: none"> Check if the grid is stably supplied; Check if the AC wiring is tight; Check if the AC cable is connected to the correct terminal (or if the fire wire is connected to the N wire); Check if the AC circuit breaker is turned on; Contact the Customer Service Center if the fault still exists not for the above reasons;

Maintenance Notes

- Avoid personnel injury or product damage due to improper maintenance!
- Always remember that the inverter is powered by dual power sources: the PV string and public Grid.

Before maintaining the inverter, obey the following steps:

- First disconnect the Grid-side AC circuit breaker, and then turn off the DC switch;
- Wait at least 10 min to discharge the internal energy-storage element completely, and then maintain or repair the internal parts of inverter;
- Use test equipment to check if the inverter is free of voltage and current;
- Post temporary warning signs or erect barriers to avoid unrelated personnel from entering the working area during electrical connections and maintenance;
- Restart the inverter after troubleshooting faults that affect the inverter's safety performance;
- Without permission, do not replace the inverter's internal components, as it does not contain repair parts;
- Contact the Customer Service Center for any maintenance service;
- The damages caused by the improper operation are not covered under the warranty, and the Company does not bear the joint liability;
- Avoid damage to devices by touching printed circuit boards or other electrostatic sensitive parts;
- Avoid unnecessary circuit board contact;
- Comply with electrostatic protection norms and wear antistatic wristbands.

Routine Maintenance

See the table below for routine maintenance items and intervals of equipment:

Item	Inspection Method	Maintenance Period
System cleaning	Check the air outlet and heat sink for dust and other blockages. If needed, clean the air outlet and heat sink.	Semi-annually–annually (as per the ambient dust content)
Equipment inlet hole	Check the equipment inlet holes for incomplete blocking or large gaps, and if so, block it tightly.	Annually
Electrical connection	Check the cable connection for looseness, detachment, and damage, especially the contact part with the metal enclosure for cuts.	Semi-annually–annually

Fan Maintenance

When the inverter is operated in a thermal environment, good ventilation and heat dissipation may minimize the chance of load shedding. The cooling fan, which is equipped outside the inverter, will reduce the excessive external temperature of the inverter. If the inverter's output power is reduced due to the excessive external temperature, the possible causes and countermeasures are listed below.

1. Clogged fan or excessive dust on the heat sink. Clean the fan, fan cover or heat sink;
2. Damaged fan. Replace it with a new fan.
3. Poor ventilation of inverter installation site. Choose a suitable installation site according to the basic installation requirements.

Fan Cleaning and Replacement Steps

1. Before cleaning or replacing the fan, ensure the DC/AC sides of the inverter are disconnected:
 - Turn off the DC switch;
 - Unplug the DC terminal (for users, use tools to disconnect the DC connection terminal);
 - Turn off AC switch.
2. Use a screwdriver to remove the plate screws of the fan shown as below:

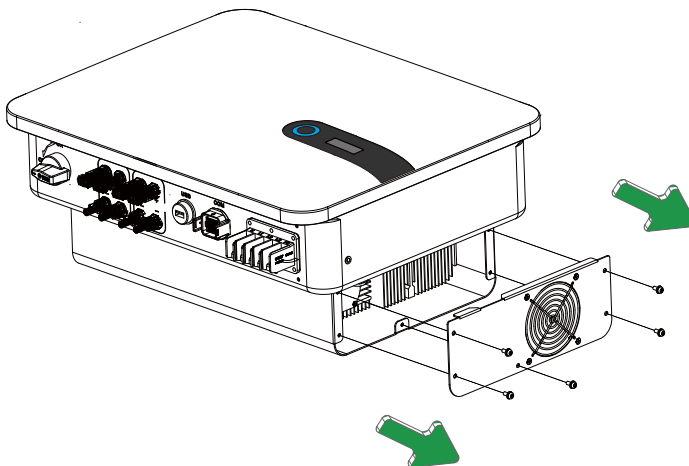

3. Disconnect the fan connector, remove the plate screws of the fan with a screwdriver, and finally remove the fan;
4. Clean the fan, fan grid, and heat sink or replace the fan:
 - Clean the heat sink with air pump, and use the brush or damp cloth to clean the fan and fan grid;
 - If needed, remove the fan and clean it separately;
 - Remove the fan to be replaced with a cross screwdriver;
 - Replace with a new fan.
5. Reinstall the fan plate and inverter.

Quality Warranty

For faulty inverters during the warranty period, **Slenergy Technology (A.H.) Co., Ltd.** will repair or replace them for free.

Proof

During the warranty period, customers are required to present the invoice and purchase date of inverter. Moreover, the trademark on the inverter shall be clearly visible, or the Slenergy assumes no liability for the warranty.

Condition

- Replaced failed inverters shall be handled by the Company;
- Customers shall reserve a reasonable time for the Company to repair faulty equipment.

Immunity From Liability

The Company assumes no liability for the warranty of the product in the event of:

- Entire inverter and/or parts beyond the free warranty period;
- Damage in transportation;
- Improper installation, modification or use;
- Operation in extremely harsh conditions beyond those described in the Manual;
- Equipment failure or damage not caused from the installation, repair, modification or disassembly by our service team and personnel;
- Non-conformance to the relevant international standards for installation and use;
- Damage caused by abnormal natural environment.

For the product failure caused by above reasons, the Company may provide paid maintenance service based on the customers' service requests which will be decided by the service institute.

As the dimension and parameter of products change, the latest information of our company shall prevail without prior notice.

Datasheet	SL17KRG-W	SL20KRG-W	SL22KRG-W	SL25KRG-W
Input Data (DC)				
Max. recommended PV power(for module STC)	25.5kW	30.3kW	33kW	37.5kW
Max. DC Voltage	1100V			
Star-up Voltage	180V			
Nominal Voltage	600V			
No. of MPP trackers	2			
No. of PV strings per MPP tracker	2/2			
Max. input current per MPPT tracker	32A x 2			
MPP Voltage Range	160 ~ 1000V			
MPP Full Power Voltage Range	500 ~ 800V			
Max. Short-circuit per MPPT tracker	40A x 2			
Overvoltage Category (OVC)	II			
Backfeed Current	0A			
Output Data (AC)				
AC Nominal Powerput Power	17kW	20kW	22kW	25kW
Max. AC Apparent Power	18.7kVA	22kVA	24.2kVA	27.5kVA
Nominal AC Voltage (Range*)	230V/400V (320 ~ 480V)			
AC Grid Frequency (Range*)	50 / 60 Hz (45~55Hz / 55~65Hz)			
Max. Output Current (PF=0.9)	28.4A	33.4A	36.8A	41.8A
Adjustable Power Factor	0.8 leading...0.8 lagging			
THDi	<3 %			
AC Grid Connection Type	3L/N/PE or 3L/PE			
Over Voltage Category (OVC)	III			
Efficiency				
MAX. Efficiency	98.4%			
European Efficiency	98.0%			
MPPT Efficiency	99.9%			
Protection Devices				
Anti Reverse Power Function	Optional			
DC Reverse Polarity Protection	YES			
DC Switch	YES			
AC/DC Surge Protection	Type II			
Insulation Resistance Monitoring	YES			
AC Short-circuit Protection	YES			
Grid Monitoring	YES			
Anti-islanding Protection	YES			
Residual-current Monitoring Unit	YES			
String Fault Monitoring	/			
AFCI Protection	Optional			
General Parameter				
Noise	≤50 dB			
Dimensions (W×H×D)	520 x 420 x 242 mm			
Weight	27.2 kg			
Protective Class	Class I			
Pollution Degree (PD)	3			
Operating Temperature Range	-25°C...60°C (>45°C derating)			
Relative Humidity	0~100%			
Altitude	4000m (>2000m derating)			
Self-consumption at Night	<1 W			
Topology	Transformerless			
Cooling	Natural Cooling			
Protection Degree	IP66			
DC Connection	H4 / MC4 (Optional)			
AC Connection	Connector			
Guarantee Period	5 Years / 10 Years (Optional)			
Display and Communication				
Display	LED / LCD			
Communication	Host: RS485+USB; Optional: 4G / Wi-Fi			
Compliance				
Compliance	NB/T32004, IEC62109-1/2, IEC62116, IEC61727, IEC61683, IEC60068(1,2,14,30), EN61000-6-1/2/3/4			



Official website of Slenergy



SMART M

Slenergy Technology (A.H.) Co., Ltd.

Add.: No.120 Yongyang Road, Chuzhou City, Anhui, P.R. China

Telephone: 400-826-5788

Email: service@slenergy.com

Website: www.slenergy.com